

| DIMENSIONS & QUANTITIES FOR HEADWALLS WITH 45° WINGS |              |       |           |           |        |           |                   |                |                  |               |                 |                |                  |                |                  |                       |                    |    |            |   |        |      |     |
|--|--------------|-------|-----------|-----------|--------|-----------|-------------------|----------------|------------------|---------------|-----------------|----------------|------------------|----------------|------------------|-----------------------|--------------------|----|------------|---|--------|------|-----|
| DIMENSIONS   |              |       |           |           |        |           | REINFORCING STEEL |                |                  |               |                 |                |                  | QUANTITIES *   |                  |                       |                    |    |            |   |        |      |     |
| D  | AREA SQ. FT. | T     | H         | K         | L      | M         | N                 | A1-1/2 phi NO. | A2-1/2 phi LGTH. | B-1/2 phi NO. | C-1/2 phi LGTH. | H1-1/2 phi NO. | H2-1/2 phi LGTH. | V1-1/2 phi NO. | V2-1/2 phi LGTH. | CLASS "A" CONC., C.Y. | REINF. STEEL, LBS. |    |            |   |        |      |     |
| 15"  | 1.23         | 2 1/4 | 2'-5 1/4  | 1'-5"     | 3'-7"  | 1'-9"     | 1'-3"             | 4              | 1'-0"            | 2             | 3'-9" Av.       | 7              | 3'-3"            | 3              | 1'-6"            | 4                     | 2'-1"              | 4  | 3'-5" Av.  | 4 | 5'-10" | 0.74 | 57  |
| 18"  | 1.77         | 2 1/2 | 2'-8 1/2  | 1'-7"     | 3'-10" | 2'-1 1/2  | 1'-6"             | 4              | 1'-2"            | 2             | 4'-3" Av.       | 7              | 3'-6"            | 3              | 1'-6"            | 4                     | 2'-6"              | 4  | 3'-8" Av.  | 4 | 6'-1"  | 0.91 | 61  |
| 24"  | 3.14         | 3"    | 3'-3"     | 1'-10 1/2 | 4'-4"  | 2'-10"    | 2'-0"             | 5              | 1'-8"            | 3             | 5'-3" Av.       | 7              | 4'-0"            | 3              | 1'-6"            | 6                     | 3'-2"              | 6  | 4'-1" Av.  | 4 | 6'-8"  | 1.31 | 85  |
| 30"  | 4.91         | 3 1/2 | 3'-9 1/2  | 2'-2"     | 4'-10" | 3'-6 1/2  | 2'-6"             | 5              | 2'-2"            | 3             | 6'-3" Av.       | 7              | 4'-6"            | 4              | 1'-6"            | 6                     | 3'-11"             | 8  | 4'-6" Av.  | 4 | 7'-2"  | 1.77 | 104 |
| 36"  | 7.07         | 4"    | 4'-4"     | 2'-5 1/2  | 5'-4"  | 4'-3"     | 3'-0"             | 6              | 2'-8"            | 4             | 7'-3" Av.       | 7              | 5'-0"            | 4              | 1'-6"            | 6                     | 4'-7"              | 10 | 4'-11" Av. | 4 | 7'-9"  | 2.29 | 130 |
| 42"  | 9.62         | 4 1/2 | 4'-10 1/2 | 2'-9"     | 5'-10" | 4'-11 1/2 | 3'-6"             | 6              | 3'-2"            | 4             | 8'-3" Av.       | 7              | 5'-6"            | 4              | 1'-6"            | 6                     | 5'-4"              | 12 | 5'-4" Av.  | 4 | 8'-3"  | 2.89 | 151 |

\* For One Headwall

| DIMENSIONS & QUANTITIES FOR STRAIGHT HEADWALLS |              |       |           |        |        |       |                   |                |                  |                |                  |                |                  |               |                 |                       |                    |    |       |      |     |
|--|--------------|-------|-----------|--------|--------|-------|-------------------|----------------|------------------|----------------|------------------|----------------|------------------|---------------|-----------------|-----------------------|--------------------|----|-------|------|-----|
| DIMENSIONS                                     |              |       |           |        |        |       | REINFORCING STEEL |                |                  |                |                  |                |                  | QUANTITIES *  |                 |                       |                    |    |       |      |     |
| D  | AREA SQ. FT. | T     | H         | L      | E      | B     | C                 | F1-1/2 phi NO. | F2-1/2 phi LGTH. | H1-1/2 phi NO. | H2-1/2 phi LGTH. | H3-1/2 phi NO. | H4-1/2 phi LGTH. | V-1/2 phi NO. | V-1/2 phi LGTH. | CLASS "A" CONC., C.Y. | REINF. STEEL, LBS. |    |       |      |     |
| 15"  | 1.23         | 2 1/4 | 2'-5 1/4  | 6'-0"  | 2'-2"  | 10"   | 6"                | 6              | 1'-10"           | 3              | 6'-0"            | 1              | 5'-8"            | 3             | 5'-3"           | 4                     | 2'-0"              | 6  | 4'-3" | 0.78 | 56  |
| 18"  | 1.77         | 2 1/2 | 2'-8 1/2  | 7'-0"  | 2'-3"  | 11"   | 6"                | 8              | 1'-11"           | 3              | 7'-0"            | 1              | 6'-8"            | 3             | 5'-6"           | 4                     | 2'-4"              | 8  | 4'-6" | 0.98 | 70  |
| 24"  | 3.14         | 3"    | 3'-3"     | 9'-0"  | 2'-7"  | 1'-3" | 6"                | 11             | 2'-3"            | 3              | 9'-0"            | 1              | 8'-8"            | 3             | 6'-0"           | 4                     | 3'-1"              | 10 | 5'-1" | 1.46 | 95  |
| 30"  | 4.91         | 3 1/2 | 3'-9 1/2  | 11'-0" | 2'-10" | 1'-4" | 8"                | 11             | 2'-6"            | 3              | 11'-0"           | 1              | 10'-8"           | 3             | 6'-6"           | 6                     | 3'-9"              | 12 | 5'-9" | 2.00 | 122 |
| 36"  | 7.07         | 4"    | 4'-4"     | 14'-0" | 3'-1"  | 1'-7" | 8"                | 16             | 2'-9"            | 4              | 14'-0"           | 1              | 13'-8"           | 3             | 7'-0"           | 6                     | 5'-0"              | 14 | 6'-4" | 2.85 | 170 |
| 42"  | 9.62         | 4 1/2 | 4'-10 1/2 | 16'-0" | 3'-4"  | 1'-8" | 10"               | 16             | 3'-0"            | 4              | 16'-0"           | 1              | 15'-8"           | 3             | 7'-6"           | 6                     | 5'-8"              | 16 | 7'-0" | 3.58 | 198 |

\* For One Headwall

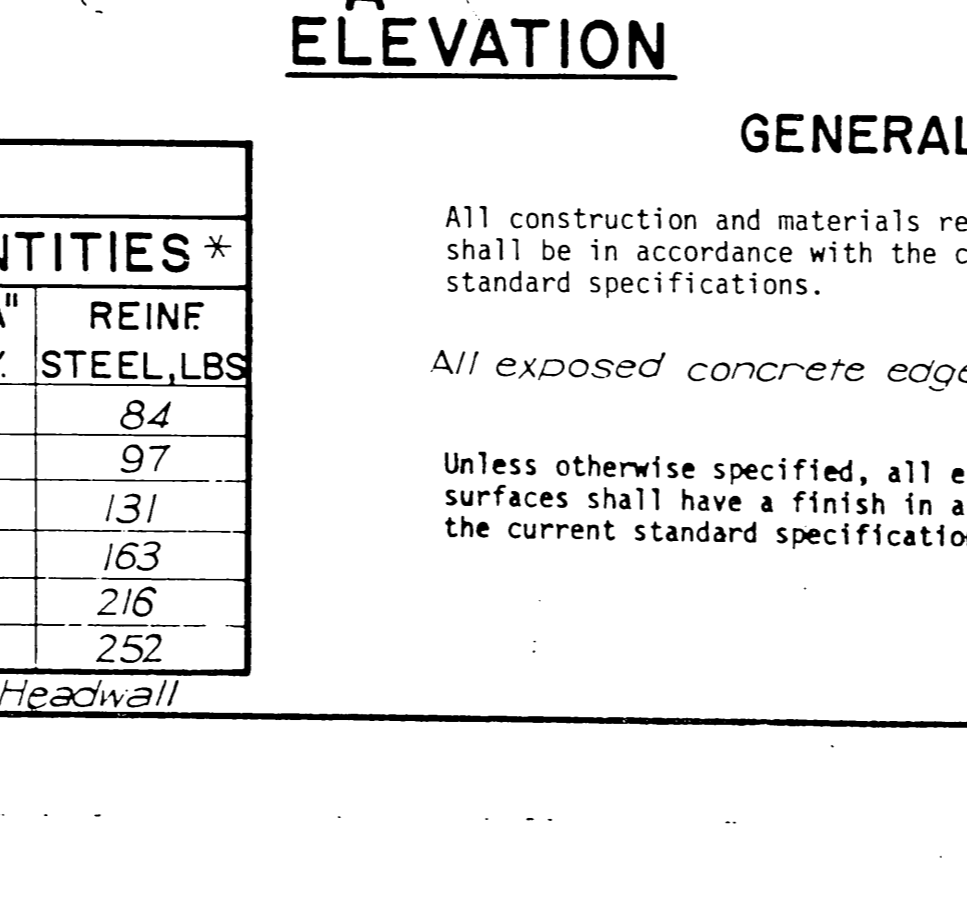
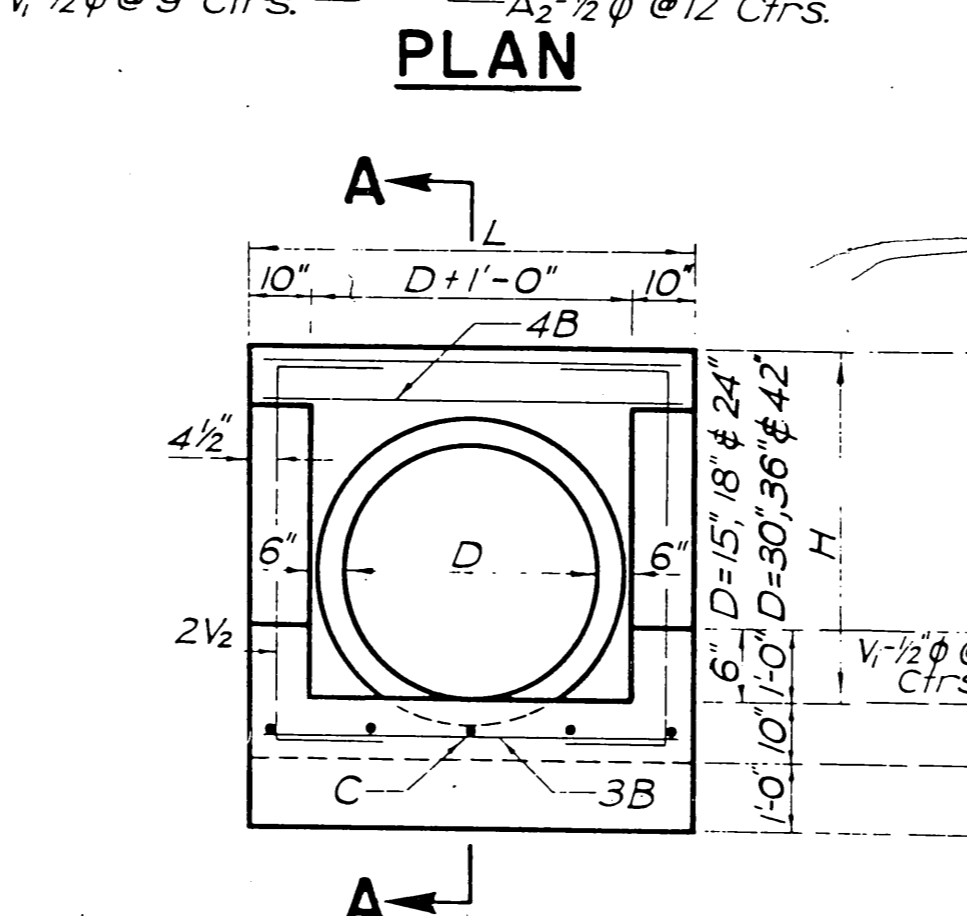
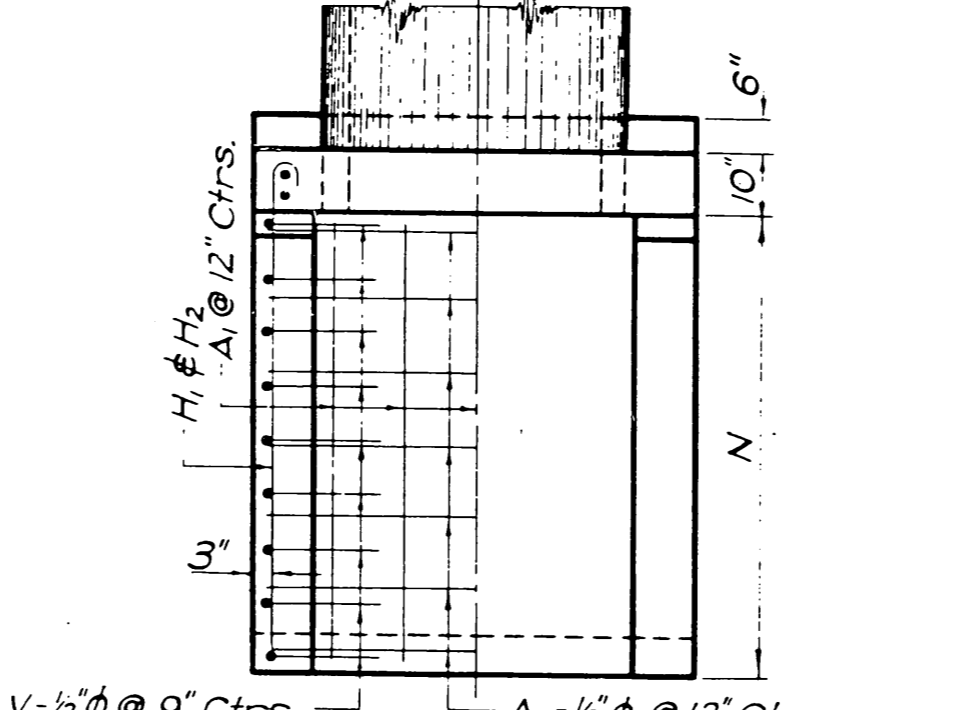
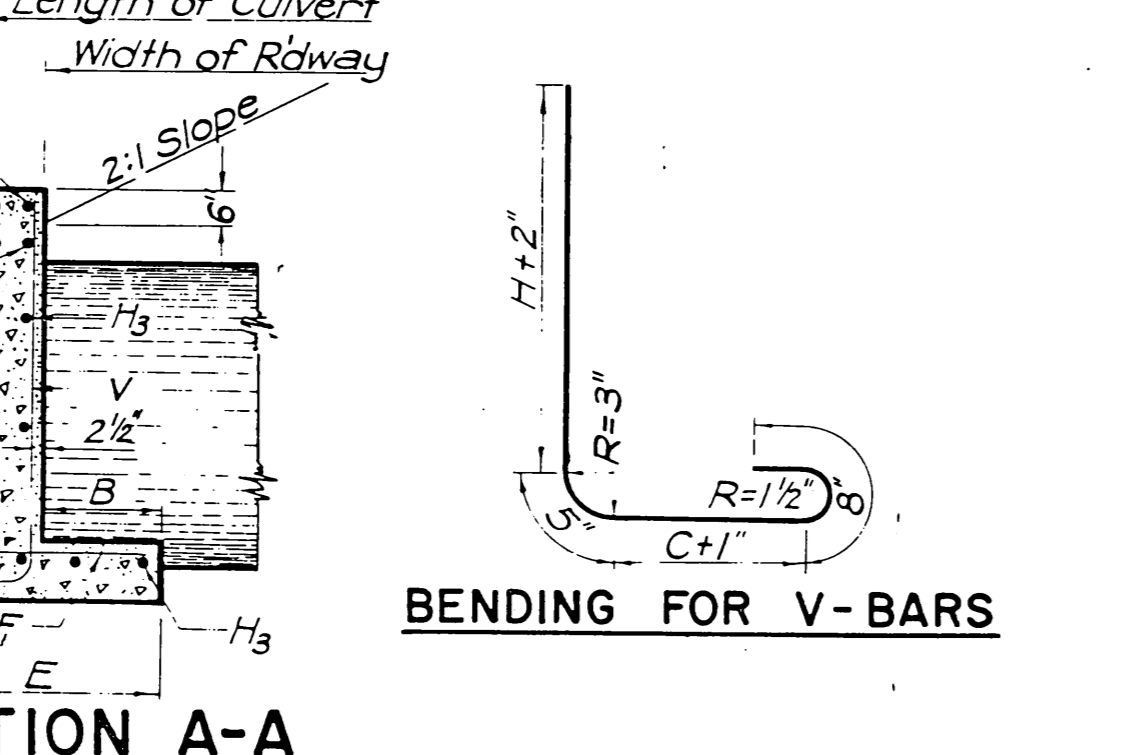
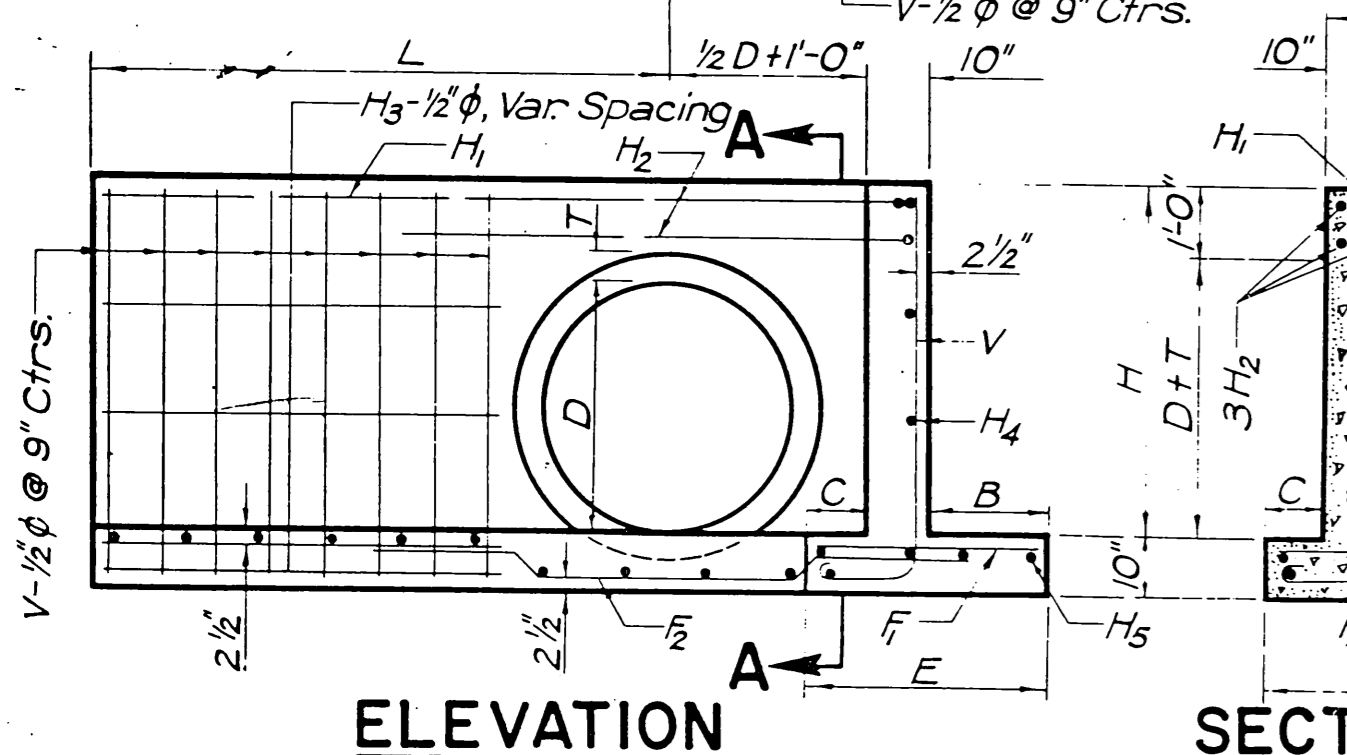
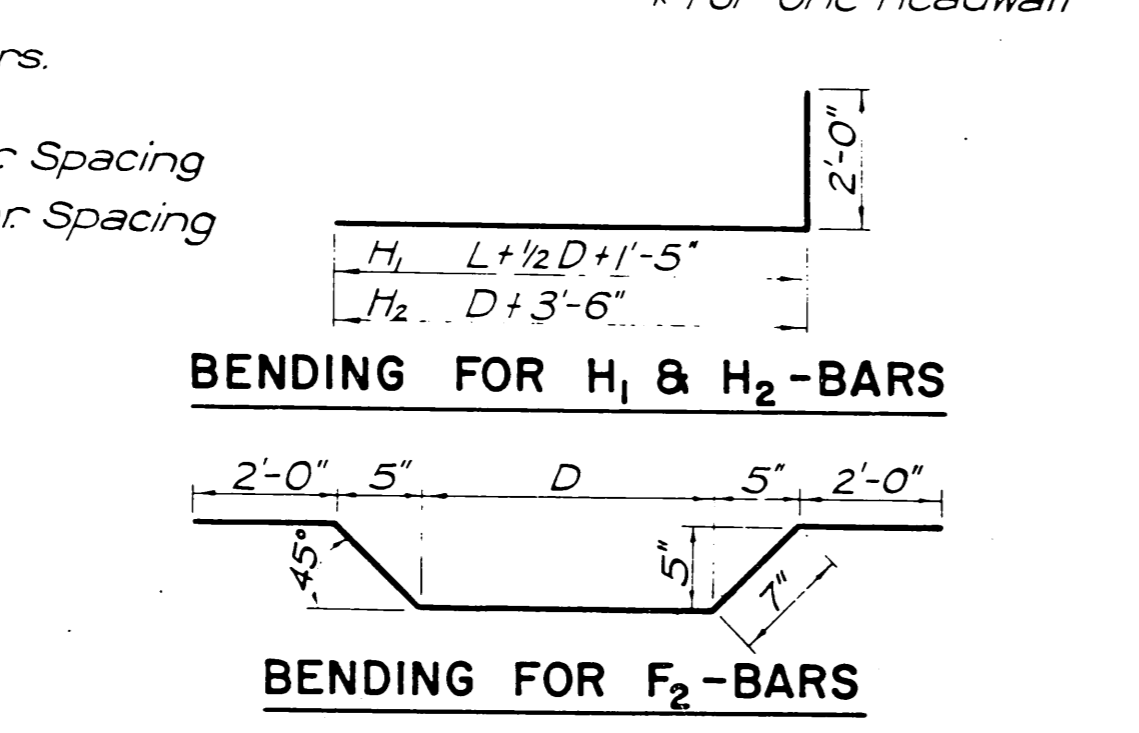
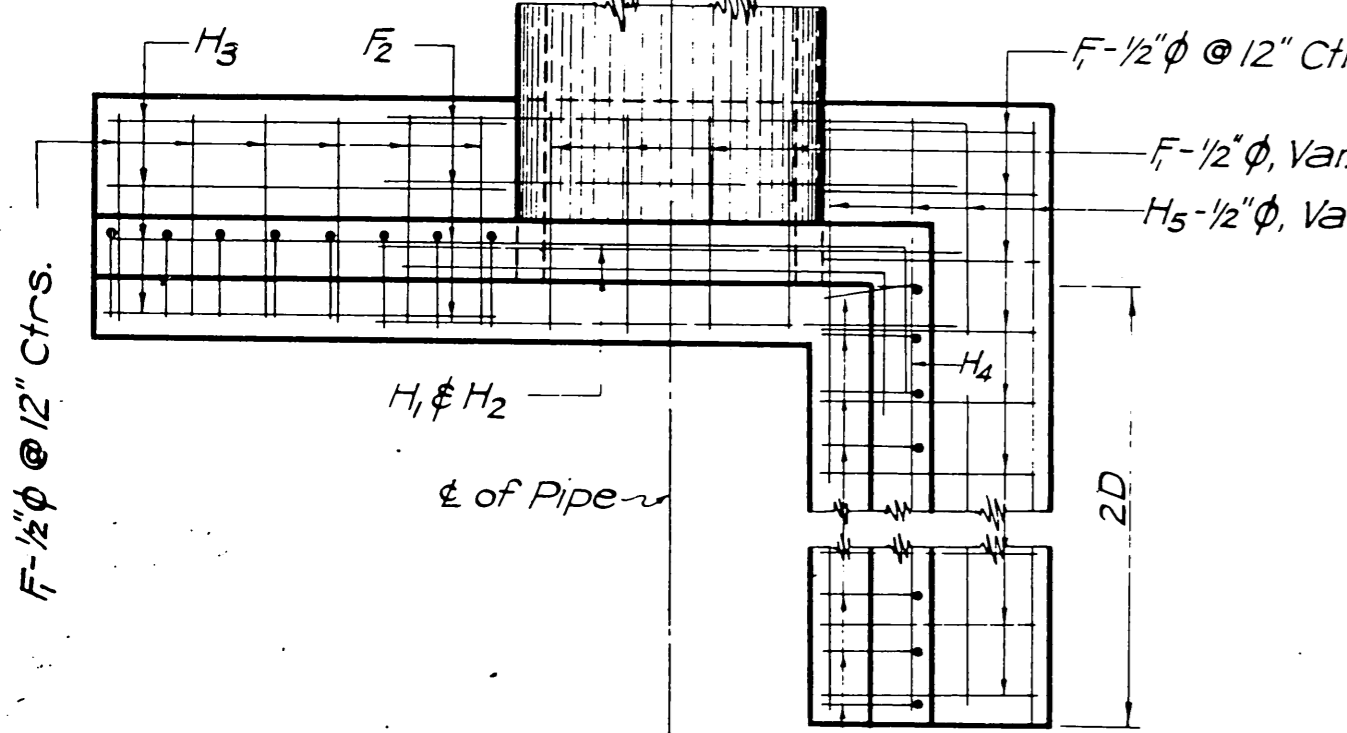

| DIMENSIONS & QUANTITIES FOR HEADWALLS WITH U-TYPE WINGS |              |       |           |        |       |                |                   |               |                 |                |                  |                |                  |                       |                    |   |            |    |            |   |        |      |     |
|---|--------------|-------|-----------|--------|-------|----------------|-------------------|---------------|-----------------|----------------|------------------|----------------|------------------|-----------------------|--------------------|---|------------|----|------------|---|--------|------|-----|
| DIMENSIONS  |              |       |           |        |       |                | REINFORCING STEEL |               |                 |                |                  |                |                  | QUANTITIES *          |                    |   |            |    |            |   |        |      |     |
| D   | AREA SQ. FT. | T     | H         | L      | N     | A1-1/2 phi NO. | A2-1/2 phi LGTH.  | B-1/2 phi NO. | C-1/2 phi LGTH. | H1-1/2 phi NO. | H2-1/2 phi LGTH. | V1-1/2 phi NO. | V2-1/2 phi LGTH. | CLASS "A" CONC., C.Y. | REINF. STEEL, LBS. |   |            |    |            |   |        |      |     |
| 15"   | 1.23         | 2 1/4 | 2'-5 1/4  | 3'-11" | 2'-6" | 3              | 2'-2"             | 3             | 3'-7"           | 7              | 3'-7"            | 3              | 1'-6"            | 2                     | 3'-6"              | 2 | 2'-0"      | 8  | 3'-0" Av.  | 4 | 5'-10" | 0.95 | 71  |
| 18"   | 1.77         | 2 1/2 | 2'-8 1/2  | 4'-2"  | 3'-1" | 3              | 2'-9"             | 4             | 3'-10"          | 7              | 3'-10"           | 3              | 1'-6"            | 2                     | 4'-1"              | 2 | 2'-8"      | 8  | 3'-1" Av.  | 4 | 6'-1"  | 1.15 | 79  |
| 24"   | 3.14         | 3"    | 3'-3"     | 4'-8"  | 4'-2" | 4              | 3'-10"            | 5             | 4'-4"           | 7              | 4'-4"            | 4              | 1'-6"            | 2                     | 5'-2"              | 4 | 2'-11" Av. | 12 | 3'-5" Av.  | 4 | 6'-8"  | 1.60 | 109 |
| 30"   | 4.91         | 3 1/2 | 3'-9 1/2  | 5'-2"  | 4'-3" | 4              | 3'-11"            | 5             | 4'-10"          | 7              | 4'-10"           | 4              | 1'-6"            | 2                     | 5'-3"              | 4 | 3'-5" Av.  | 12 | 3'-11" Av. | 4 | 7'-2"  | 1.91 | 120 |
| 36"   | 7.07         | 4"    | 4'-4"     | 5'-8"  | 5'-4" | 5              | 5'-0"             | 6             | 5'-4"           | 7              | 5'-4"            | 5              | 1'-6"            | 2                     | 6'-4"              | 6 | 3'-11" Av. | 14 | 4'-2" Av.  | 4 | 7'-9"  | 2.48 | 152 |
| 42"   | 9.62         | 4 1/2 | 4'-10 1/2 | 6'-2"  | 6'-5" | 5              | 6'-1"             | 7             | 5'-10"          | 7              | 5'-10"           | 5              | 1'-6"            | 2                     | 7'-5"              | 6 | 4'-10" Av. | 18 | 4'-6" Av.  | 4 | 8'-3"  | 3.12 | 186 |

\* For One Headwall

| DIMENSIONS & QUANTITIES FOR HEADWALLS WITH 90° WINGS |              |       |           |       |        |       |                   |                |                  |                |                  |                |                  |                |                  |               |                 |                       |                    |   |        |    |       |      |     |
|--|--------------|-------|-----------|-------|--------|-------|-------------------|----------------|------------------|----------------|------------------|----------------|------------------|----------------|------------------|---------------|-----------------|-----------------------|--------------------|---|--------|----|-------|------|-----|
| DIMENSIONS   |              |       |           |       |        |       | REINFORCING STEEL |                |                  |                |                  |                |                  | QUANTITIES *   |                  |               |                 |                       |                    |   |        |    |       |      |     |
| D  | AREA SQ. FT. | T     | H         | L     | E      | B     | C                 | F1-1/2 phi NO. | F2-1/2 phi LGTH. | H1-1/2 phi NO. | H2-1/2 phi LGTH. | H3-1/2 phi NO. | H4-1/2 phi LGTH. | H5-1/2 phi NO. | H5-1/2 phi LGTH. | V-1/2 phi NO. | V-1/2 phi LGTH. | CLASS "A" CONC., C.Y. | REINF. STEEL, LBS. |   |        |    |       |      |     |
| 15"  | 1.23         | 2 1/4 | 2'-5 1/4  | 3'-0" | 2'-2"  | 10"   | 6"                | 10             | 1'-10"           | 3              | 6'-5"            | 1              | 7'-0"            | 3              | 6'-9"            | 5             | 2'-0"           | 2                     | 3'-0"              | 4 | 3'-10" | 7  | 4'-3" | 1.09 | 84  |
| 18"  | 1.77         | 2 1/2 | 2'-8 1/2  | 3'-6" | 2'-3"  | 11"   | 6"                | 10             | 1'-11"           | 3              | 6'-8"            | 1              | 7'-8"            | 3              | 7'-0"            | 5             | 2'-4"           | 2                     | 3'-6"              | 4 | 4'-5"  | 9  | 4'-6" | 1.32 | 97  |
| 24"  | 3.14         | 3"    | 3'-3"     | 4'-6" | 2'-7"  | 1'-3" | 6"                | 14             | 2'-3"            | 3              | 7'-2"            | 1              | 8'-11"           | 3              | 7'-6"            | 6             | 3'-1"           | 3                     | 4'-6"              | 4 | 5'-9"  | 11 | 5'-1" | 1.94 | 131 |
| 30"  | 4.91         | 3 1/2 | 3'-9 1/2  | 5'-6" | 2'-10" | 1'-4" | 8"                | 16             | 2'-6"            | 3              | 7'-8"            | 1              | 10'-2"           | 3              | 8'-0"            | 6             | 3'-9"           | 3                     | 5'-6"              | 4 | 6'-10" | 14 | 5'-9" | 2.59 | 163 |
| 36"  | 7.07         | 4"    | 4'-4"     | 7'-0" | 3'-1"  | 1'-7" | 8"                | 19             | 2'-9"            | 4              | 8'-2"            | 1              | 11'-11"          | 3              | 8'-6"            | 7             | 5'-0"           | 4                     | 6'-6"              | 4 | 8'-1"  | 17 | 6'-4" | 3.47 | 216 |
| 42"  | 9.62         | 4 1/2 | 4'-10 1/2 | 8'-0" | 3'-4"  | 1'-8" | 10"               | 21             | 3'-0"            | 4              | 8'-8"            | 1              | 13'-2"           | 3              | 9'-0"            | 7             | 5'-8"           | 4                     | 7'-6"              | 4 | 9'-2"  | 19 | 7'-0" | 4.32 | 252 |

\* For One Headwall

GENERAL NOTES

All construction and materials requirements shall be in accordance with the current standard specifications.

All exposed concrete edges shall have a 3/4 chamfer.

Unless otherwise specified, all exposed concrete surfaces shall have a finish in accordance with the current standard specifications.

| REVISIONS |                        | RECORD |         |
|-----------|------------------------|--------|---------|
| NO.       | DESCRIPTION            | BY     | DATE    |
| 1         | Note for Reinf. Wts.   | FWS    | 5-7-63  |
| 2         | Rev. Reinf. Steel Wts. | GMW    | 5-23-63 |
| 3         | Rev. General Notes     | LED    | 9-27-63 |
| 4         | Retraced               | TEA    |         |
| 5         | Rev. Spec. Reference   | LED    | 1-31-67 |

| OKLAHOMA DEPARTMENT OF TRANSPORTATION |          |         |             |
|---------------------------------------|----------|---------|-------------|
| OKLAHOMA CITY, OKLAHOMA               |          |         |             |
| DESIGN                                | BY DATE  | TRACED  | JWW 7-47    |
| DETAIL                                | FRC 7-47 | CHECKED | HH AWY 3-48 |
| APPROVED                              | DIM 3-48 | SQUAD   |             |

STANDARD CONCRETE HEADWALLS FOR 15" TO 42" REINF. CONC. PIPES

020 4/6/89