









LEGEND - SYMBOLS

-  EXISTING POLE AND BASE
-  PROPOSED POLE AND BASE
-  TRAFFIC PULLBOX
-  SIGNAL CABINET
-  FIRE HYDRANT
-  UTILITY POLE
-  SIGNAL HEAD (TYPE INDICATED)
-  CONDUIT WITH CONDUCTOR
-  LUMINAIRE

NOTE ON POLE LOCATION:
 DESIGNATION SHOWN FOR EACH POLE IS THE
 OFFSET FROM CURBLINE TO CENTER OF POLE:
 -1ST NUMBER IS OFFSET FROM EAST-WEST CURBLINE
 -2ND NUMBER IS OFFSET FROM NORTH-SOUTH CURBLINE

- LEGEND - ITEMS OF WORK**
- (A) REMOVE POLE AND BASE
 - (B) INSTALL POLE AND BASE
 - (C) INSTALL CONDUIT AND CONDUCTOR
(2"/20-C, UNLESS NOTED OTHERWISE)
 - (D) REPLACE OR INSTALL PULLBOX
(TYPE 2, UNLESS NOTED OTHERWISE)
 - (E) REMOVE AND REPLACE SIDEWALK

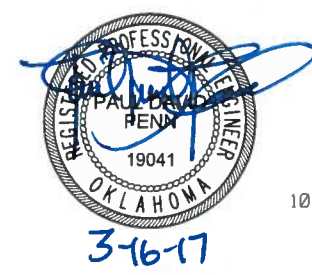
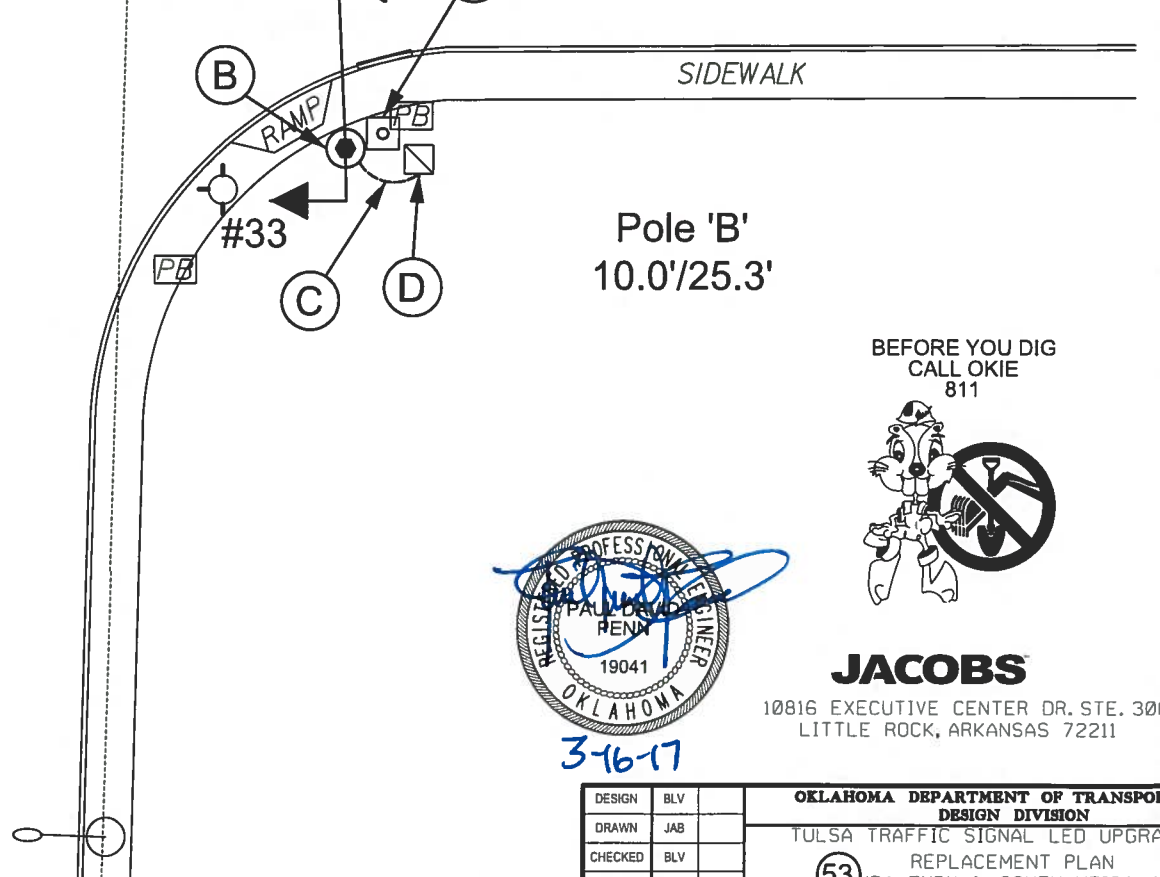
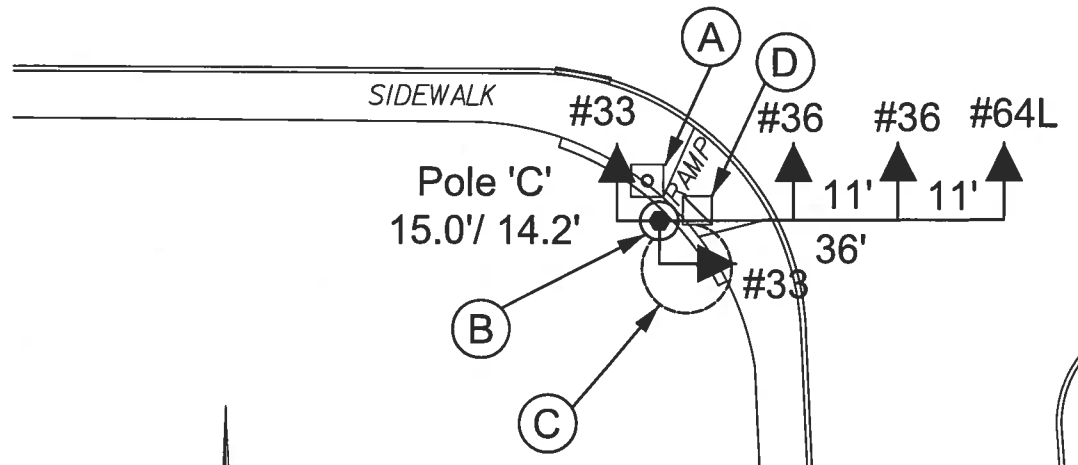
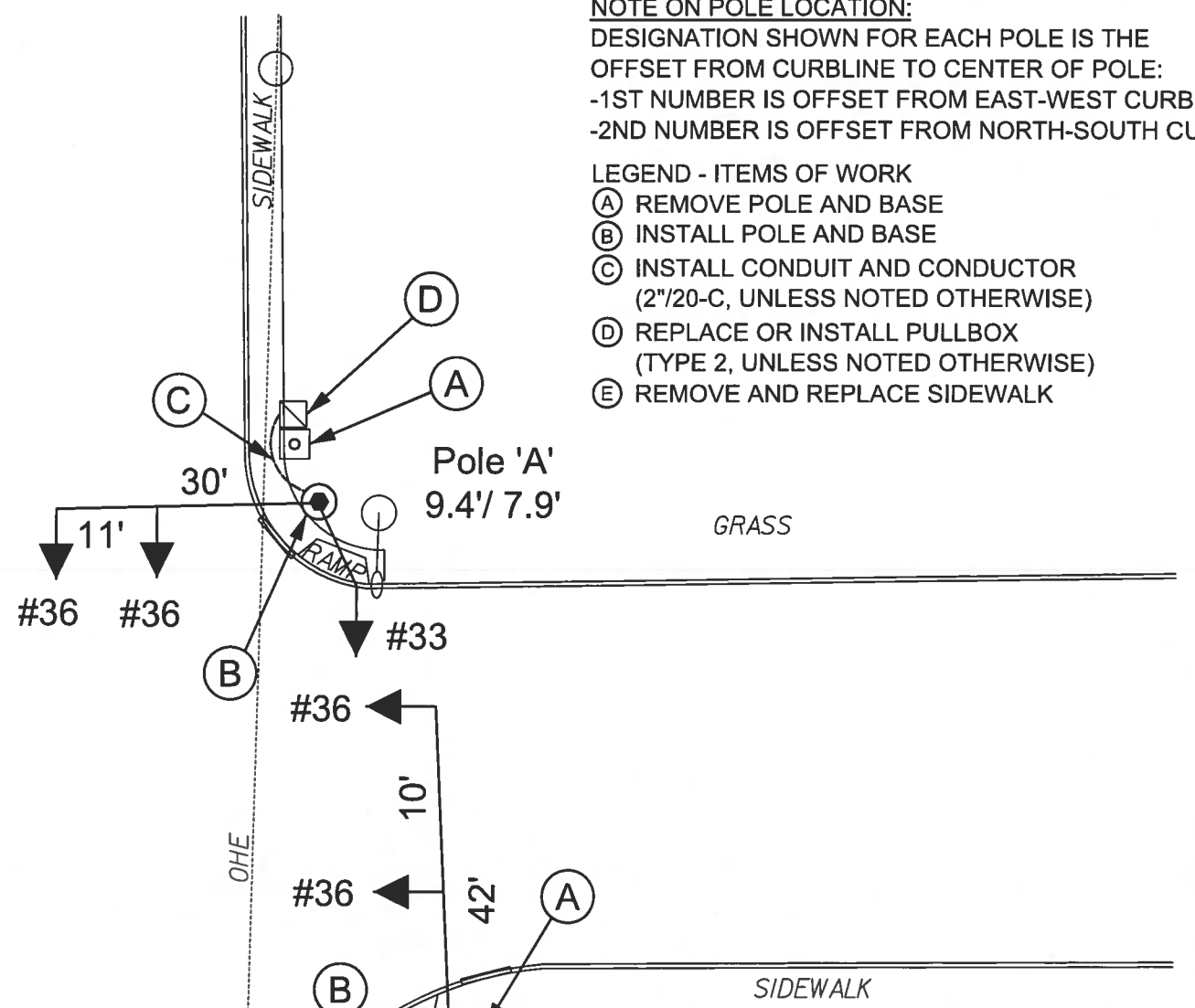
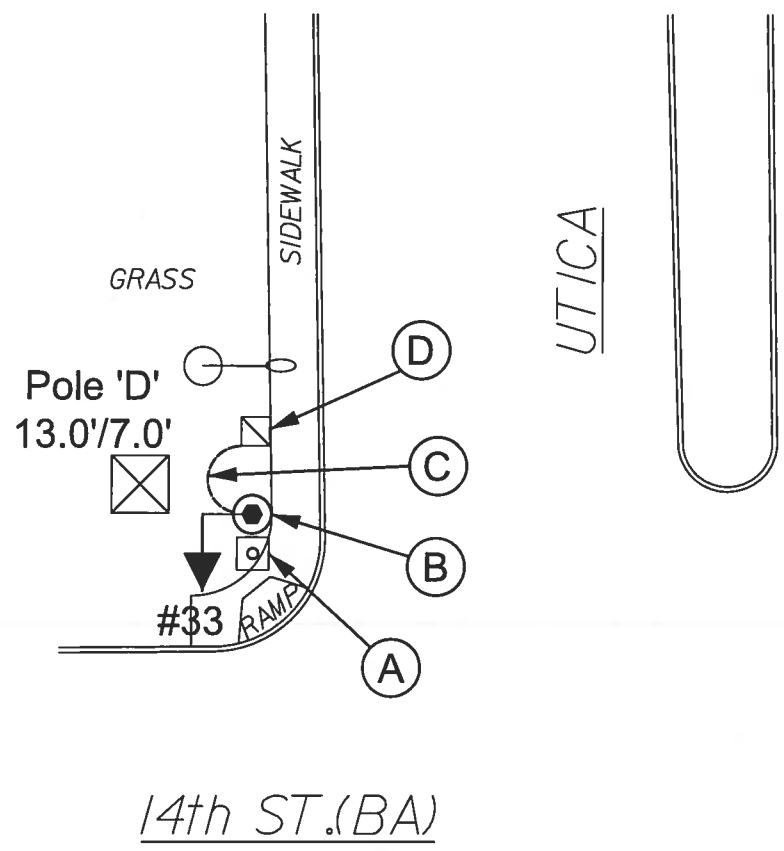

JACOBS
 10816 EXECUTIVE CENTER DR. STE. 300
 LITTLE ROCK, ARKANSAS 72211

| | | |
|----------|--------|---|
| DESIGN | BLV | OKLAHOMA DEPARTMENT OF TRANSPORTATION DESIGN DIVISION TULSA TRAFFIC SIGNAL LED UPGRADE PROJECT REPLACEMENT PLAN (BA EXPY. & SOUTH UTICA AVE.) PROJECT NO. 23708(06) SHEET NO. 36 |
| DRAWN | JAB | |
| CHECKED | BLV | |
| APPROVED | BLV | |
| SQUAD | Jacobs | |