











LEGEND - SYMBOLS

-  EXISTING POLE AND BASE
-  PROPOSED POLE AND BASE
-  TRAFFIC PULLBOX
-  SIGNAL CABINET
-  FIRE HYDRANT
-  UTILITY POLE
-  SIGNAL HEAD (TYPE INDICATED)
-  CONDUIT WITH CONDUCTOR
-  LUMINAIRE
-  SIGN

NOTE ON POLE LOCATION:

DESIGNATION SHOWN FOR EACH POLE IS THE OFFSET FROM CURBLINE TO CENTER OF POLE:
 -1ST NUMBER IS OFFSET FROM EAST-WEST CURBLINE
 -2ND NUMBER IS OFFSET FROM NORTH-SOUTH CURBLINE

LEGEND - ITEMS OF WORK

- (A) REMOVE POLE AND BASE
- (B) INSTALL POLE AND BASE
- (C) INSTALL CONDUIT AND CONDUCTOR (2"/20-C, UNLESS NOTED OTHERWISE)
- (D) REPLACE OR INSTALL PULLBOX (TYPE 2, UNLESS NOTED OTHERWISE)
- (E) REMOVE AND REPLACE SIDEWALK

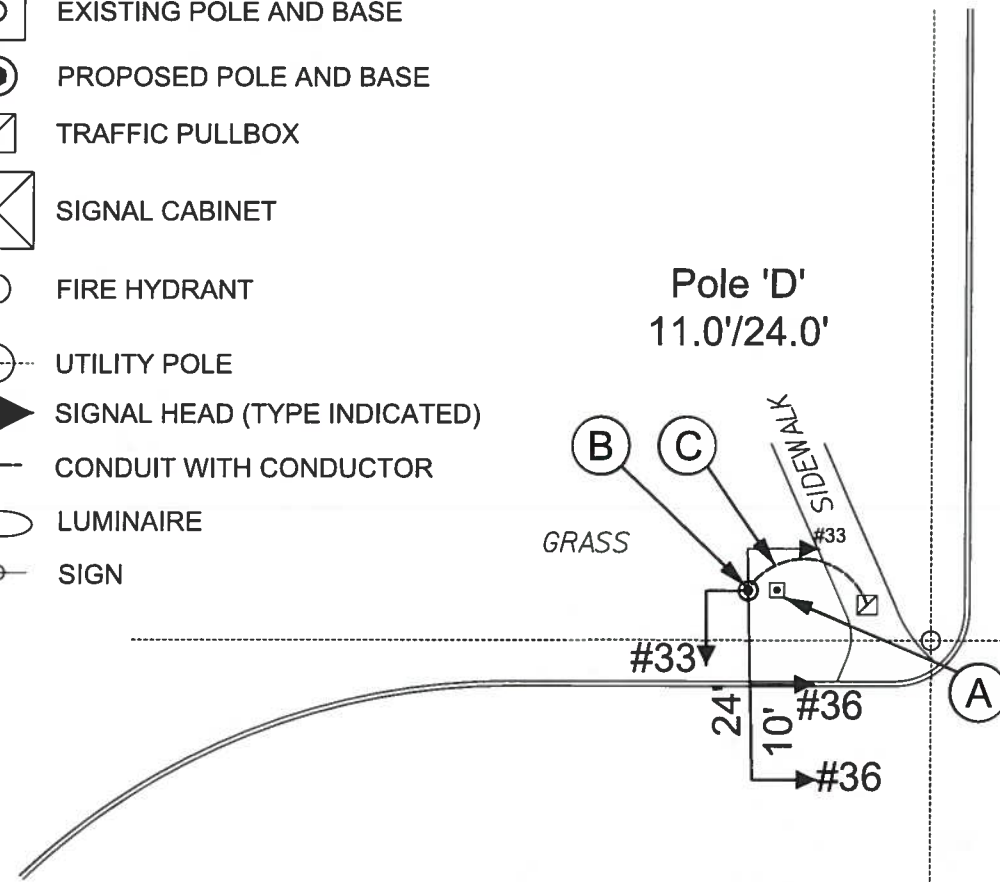

35TH ST.

MEMORIAL

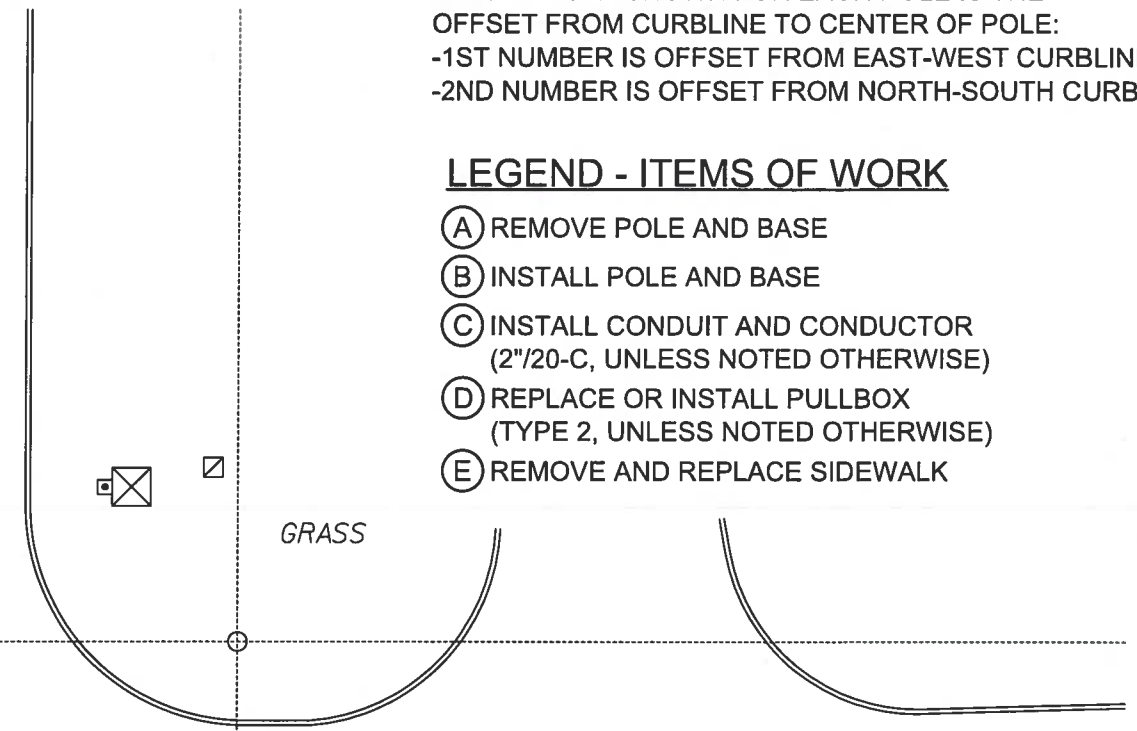

Pole 'B'
4.5'/11.8'

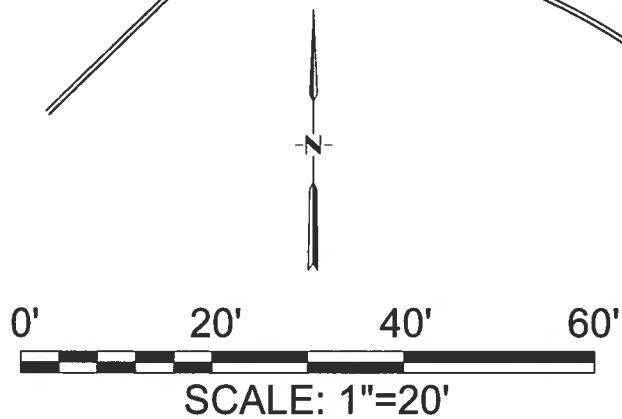

31617

BEFORE YOU DIG
CALL OKIE
811



JACOBS

10816 EXECUTIVE CENTER DR. STE. 300
LITTLE ROCK, ARKANSAS 72211

DESIGN	BLV	OKLAHOMA DEPARTMENT OF TRANSPORTATION DESIGN DIVISION TULSA TRAFFIC SIGNAL LED UPGRADE PROJECT REPLACEMENT PLAN (35th ST. & MEMORIAL DR.) PROJECT NO. 23708(06) SHEET NO. 29
DRAWN	JAB	
CHECKED	BLV	
APPROVED	BLV	
SQUAD	Jacobs	